

9

METRIC®

Bathroom Accessories

- 3 Features
- 4 Material & Finishes
- 5 Overview
- 6 Bathroom Accessories
- 16 Specification Details



The bathroom is increasingly becoming a place for tranquillity and relaxation. As a result, notions of how such spaces are designed are having to be reconsidered too. The atmosphere of a space plays an increasingly important part alongside purely functional requirements.

Factors such as “natural quality”, “simplicity” and “wellbeing” are setting new standards both in the domestic sphere as well as in hotels and public areas. Growing significance is attached to the process of selecting and combining natural materials, finishes and colors. FSB is addressing this trend in the design of its METRIC® range of bathroom accessories.

The METRIC® design is deliberately understated, being defined by geometric shapes and high quality materials. The contrast between round roses and rectangular support profiles is a striking design feature that runs through the entire range. The combination of round functional parts and the supports made of rectangular profiles underscores the clear division of the system’s constituent parts.

Its astutely balanced proportions have a soothing effect and blend harmoniously with a variety of design concepts. Ergonomic criteria have been taken into account wherever they are an aid to fluent sequences of movements. The holder for the toothbrush mug, for instance, tilts towards the user, thus making it easier to remove the mug.

METRIC® is supplied in stainless steel satin finish or polished. Besides looking good, stainless steel boasts an authenticity that harmonises particularly well with natural materials such as wood or granite and is excellently suited to well-appointed bathroom schemes. Stainless steel rightly lays claim to being exceedingly hard wearing, corrosion resistant, easy to look after and durable.

The quality with which FSB works stainless steel draws on decades of experience gained as a manufacturer of well-designed, finely machined hardware for doors and windows. This expertise has found its way into the design and production of the METRIC® range of bathroom accessories.

Fastening

The base rose features two parallel longitudinal slots for optimum dimensional coordination and is screwed to the wall with the fastenings supplied. The cover rose is then placed on top and aligned with the patterning as required. The final optical adjustment of the working parts is performed by firmly tightening the socket screw against the tensioning bolt.

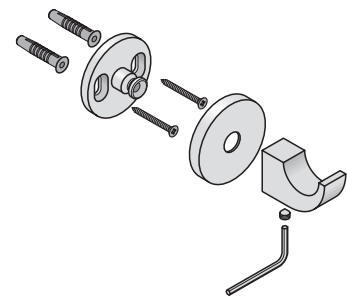

As an alternative to conventional screw fastening, FSB also offers attachment by means of a bonding technique that is highly adhesive and facilitates residue-free removal.

METRIC®

Material & Finishes



FSB 6204
Stainless steel, satin (630)



FSB 6205
Stainless steel, polished (629)

The generic term “stainless steel” embraces over 100 different rust and acid resistant steels. We use a chromium-nickel steel in the ErgoSystem that bears the material No. 1.4301 in conformity to DIN 17440. It contains approx. 18% chromium and 8% nickel. This is an alloy that has proved its worth in the construction sector.

Properties that speak for themselves

Stainless steel is just the thing for use in bathrooms and sanitary spaces owing to its surface being extremely corrosion-resistant, resisting bumps and scratches however roughly used, showing little wear even if in constant use, and – primarily on account of its chromium and nickel content – being very easy to look after. An invisible passive film forms on the surface that is even said to have disinfectant properties. FSB supplies its METRIC® in the finishes stainless steel satin (FSB 6204) and stainless steel polished (FSB 6205). The stock stainless steel satin version is particularly resilient. The stainless steel polished variant is an environmentally friendly alternative to chrome-plated finishes.

Overview

82 8270 00014 ■
Page 6



82 8270 01013 ■
Page 6



82 8270 00021 ■
Page 7



82 8270 00011 ■
Page 7



82 8270 00010 ■
Page 7



82 8270 00015/16 ■
Page 8



82 8270 00041 ■
Page 9



82 8270 00040 ■
Page 9



82 8270 00017 ■
Page 9



82 8270 01030 ■
Page 10



82 8270 01031 ■
Page 10



82 8270 00042 ■
Page 11



82 8270 00043 ■
Page 11



82 8270 00001/02 ■
Page 13



82 8270 00003 ■
Page 13



82 8270 00050 ■
Page 12



82 8201 ■
Page 14



82 8241 ■
Page 14



82 8243 ■
Page 15



All details subject to modification

METRIC®
Bathroom Accessories

82 8270 00014 ■

Combination towel rack and towel bar

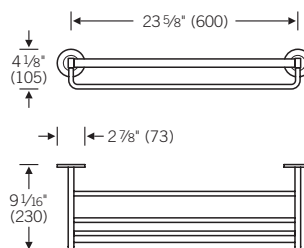

82 8270 01013 ■

Towel ring

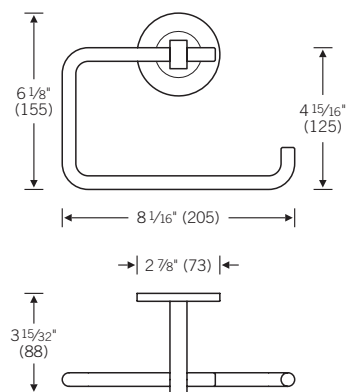

All details subject to modification

METRIC®
Bathroom Accessories

82 8270 00021 ■

Double towel bar

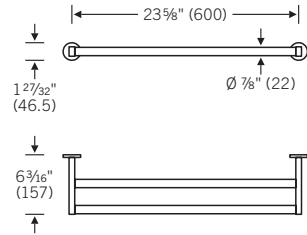

82 8270 xxx11 ■

Single towel bar

- 82 8270 04511 (450 mm)
- 82 8270 00011 (600 mm)
- 82 8270 07511 (750 mm)
- 82 8270 09011 (900 mm)

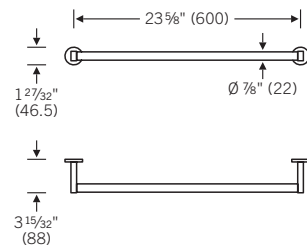

82 8270 00010 ■

Swivel action double towel bar

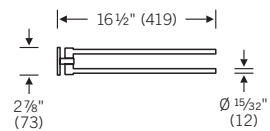

All details subject to modification

METRIC® Bathroom Accessories

82 8270 00015 ■

Frosted glass shelf

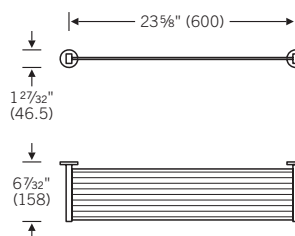

82 8270 00016 ■

Clear glass shelf

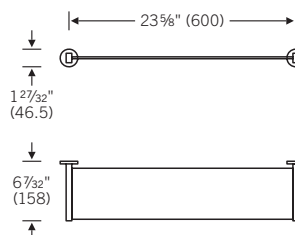

All details subject to modification

METRIC®
Bathroom Accessories

82 8270 00041 ■

Glass holder with glass

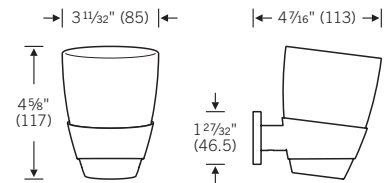

82 8270 00040 ■

Soap holder with soap dish

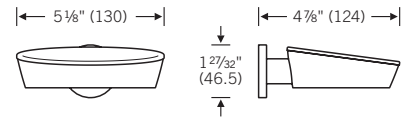

82 8270 00017 ■

Toothbrush holder

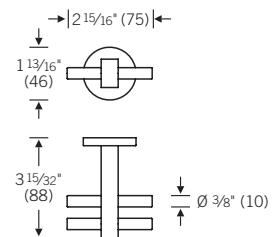

All details subject to modification

METRIC®
Bathroom Accessories

82 8270 01030 ■

Toilet roll holder

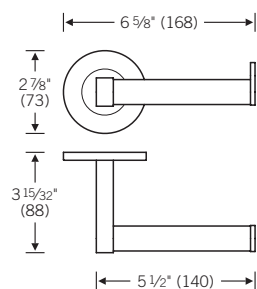

82 8270 01031 ■

Reserve toilet roll holder for one roll

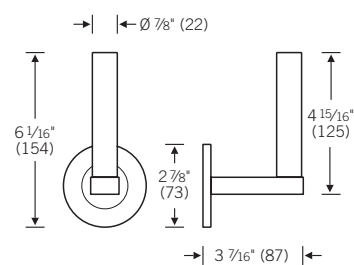

All details subject to modification

METRIC®

Bathroom Accessories

82 8270 00042 ■

Toilet brush set oval, with removable plastic insert*

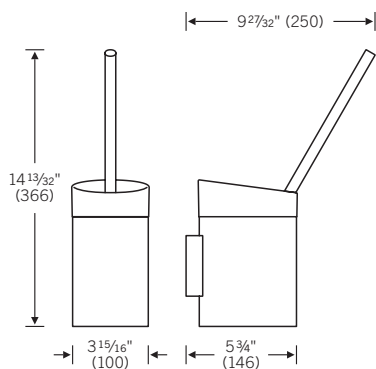

82 8270 00043 ■

Toilet brush set round, with removable plastic insert*

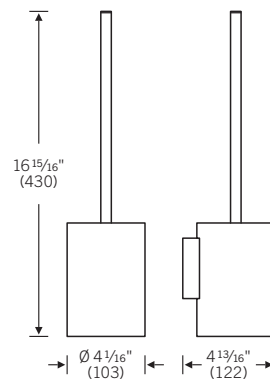

* The removable plastic insert for the toilet brush sets is washable up to 266 °F. The brush heads can be replaced and ordered separately.

All details subject to modification

METRIC®

Bathroom Accessories

82 8270 00050 ■

Slide rail with shower head holder for wall mounting



The new shower head holder enables convenient showering: it combines an ergonomically shaped handle that is safe and easy to operate without any turning action involved and features a maintenance-free, continuously adjustable height and tilt mechanism.

The shower head holder can be conveniently adjusted with one hand – leaving the other free at all times and giving the user the opportunity, for instance, to hold onto a grab handle.

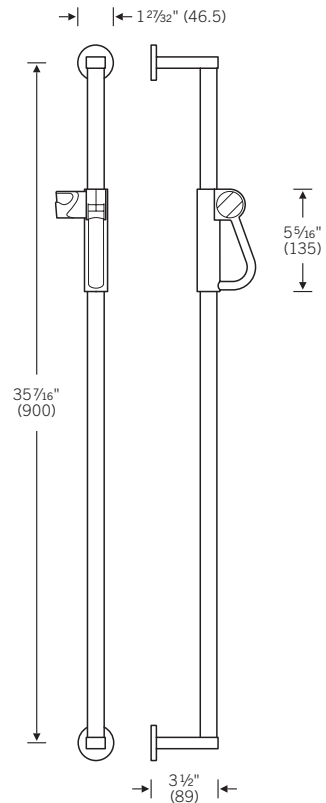

All details subject to modification



reddot design award
winner 2008

Innovationspreis



architecture + health

METRIC®

Bathroom Accessories

82 8270 00001 ■
 82 8270 00002 ■

Robe or towel hooks

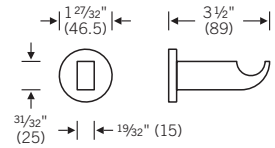
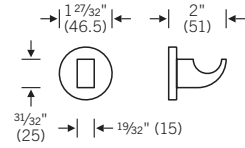

82 8270 00003 ■

Door Stop

Custom length available

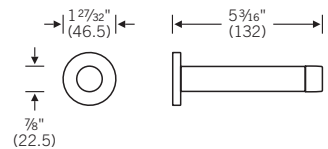

All details subject to modification

METRIC®
Bathroom Accessories

82 8201 xxx00 ■



Grab bar

- 82 8201 03000 (L = 300 mm)
- 82 8201 04500 (L = 450 mm)
- 82 8201 06000 (L = 600 mm)
- 82 8201 09000 (L = 900 mm)

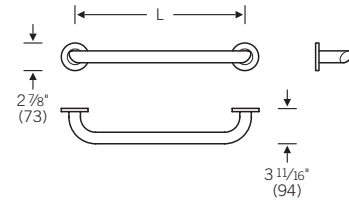

82 8241 ■ Seat PUR



Bath stool with rotating seat

The height-adjustable bath stool with rotating seat is designed with comfort in mind. Propped up against the edge of the bath, it makes getting into the bath easier. Further bathroom functions such as body care or getting dressed/undressed are likewise facilitated.

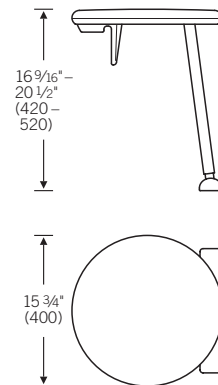

All details subject to modification

METRIC® Bathroom Accessories

82 8243 ■ Seat PUR

Free-standing bath stool with rotating seat

The free-standing stool has a rotating seat and is very convenient in the bathroom and for getting dressed/undressed.

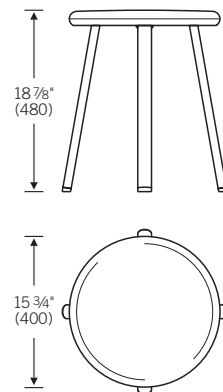

All details subject to modification

METRIC®

Specification Details

82 8270 00001

FSB METRIC bathroom accessory, robe or towel hook in stainless steel, wall mounting with concealed fastening and cover rose in stainless steel, Ø 46 mm. Includes fasteners for solid masonry, wood or drywall. Wall construction must be provided with order. Length 51 mm

82 8270 00002

FSB METRIC bathroom accessory, robe or towel hook in stainless steel, wall mounting with concealed fastening and cover rose in stainless steel, Ø 46 mm. Includes fasteners for solid masonry, wood or drywall. Wall construction must be provided with order. Length 89 mm

82 8270 00003

FSB METRIC bathroom accessory, door stop in stainless steel, wall mounting with concealed fastening and cover rose in stainless steel, Ø 46 mm. Includes fasteners for solid masonry, wood or drywall. Wall construction must be provided with order. Length 132 mm

82 8270 00010

FSB METRIC bathroom accessory, swivel action double towel bar in stainless steel, Ø 12 mm, wall mounting with concealed fastening and cover rose in stainless steel, Ø 73 mm. Includes fasteners for solid masonry, wood or drywall. Wall construction must be provided with order. Length 419 mm

82 8270 xxx11

FSB METRIC bathroom accessory, towel bar in stainless steel, Ø 22 mm mounting brackets in stainless steel, wall mounting with concealed fastening and cover roses in stainless steel, Ø 46 mm. Includes fasteners for solid masonry, wood or drywall. Wall construction must be provided with order.

82 8270 04511 Length 450 mm

82 8270 00011 Length 600 mm

82 8270 07511 Length 750 mm

82 8270 09011 Length 900 mm

82 8270 00014

FSB METRIC bathroom accessory, combination towel rack and towel bar in stainless steel, wall mounting with concealed fastening and cover rose in stainless steel, Ø 73 mm, 230 mm deep rack with Ø 22 mm towel bar. Includes fasteners for solid masonry, wood or drywall. Wall construction must be provided with order.

82 8270 00015

FSB METRIC bathroom accessory, glass wall-mounted shelf, in unbreakable glass (toughened safety glass), mounting brackets in stainless steel, plastic wall mounting with concealed fastening and cover roses in stainless steel, Ø 46 mm. Includes fasteners for solid masonry, wood or drywall. Wall construction must be provided with order. Surface area of tray 600 × 135 mm. Frosted finish

82 8270 00016

FSB METRIC bathroom accessory, glass wall-mounted shelf, in unbreakable glass (toughened safety glass), mounting brackets in stainless steel, plastic wall mounting with concealed fastening and cover roses in stainless steel, Ø 46 mm. Includes fasteners for solid masonry, wood or drywall. Wall construction must be provided with order. Surface area of tray 600 × 135 mm. Plain glass finish

82 8270 00017

FSB METRIC bathroom accessory, toothbrush holder in stainless steel, wall mounting with concealed fastening and cover rose, Ø 46 mm, in stainless steel. Includes fasteners for solid masonry, wood or drywall. Wall construction must be provided with order.

82 8270 00021

FSB METRIC bathroom accessory, double towel bar in stainless steel, Ø 22 mm mounting brackets in stainless steel, wall mounting with concealed fastening and cover roses in stainless steel, Ø 46 mm. Includes fasteners for solid masonry, wood or drywall. Wall construction must be provided with order. Length 600 mm

82 8270 00040

FSB METRIC bathroom accessory, soap holder in stainless steel, for washstand, with removable plastic soap tray (polycarbonate), wall mounting with concealed fastening and cover rose in stainless steel, Ø 46 mm. Includes fasteners for solid masonry, wood or drywall. Wall construction must be provided with order.

METRIC®

Specification Details

82 8270 00041

FSB METRIC bathroom accessory, glass holder in stainless steel, for washstand, with removable glass beaker. Ergonomic styling, tilting of holder conducive to ease of removal, wall mounting with concealed fastening and cover rose in stainless steel, Ø 46 mm. Includes fasteners for solid masonry, wood or drywall. Wall construction must be provided with order.

82 8270 00042

FSB METRIC bathroom accessory, toilet brush set in stainless steel and plastic (polycarbonate), for wall fastening, nylon brush head. Replaceable brush is automatically centred and positioned, for removal in line with body movements, large insertion aperture, easy to clean due to removable brush receptacle, with inner reservoir for disinfectants, concealed fastening. Includes fasteners for solid masonry, wood or drywall. Wall construction must be provided with order.

82 8270 00043

FSB METRIC bathroom accessory, toilet brush set in stainless steel and plastic (polycarbonate), for wall fastening, nylon brush head. Replaceable brush is automatically centred and positioned, for removal in line with body movements, large insertion aperture, easy to clean due to removable brush receptacle, with inner reservoir for disinfectants, concealed fastening. Includes fasteners for solid masonry, wood or drywall. Wall construction must be provided with order.

82 8270 00050

FSB METRIC bathroom accessory, shower rail in stainless steel, Ø 22 mm, with continuously adjustable shower head holder, supports in stainless steel, wall mounting with concealed fastening and cover rose in stainless steel, Ø 46 mm. Includes fasteners for solid masonry, wood or drywall. Wall construction must be provided with order. Length 900 mm

82 8270 01013

FSB METRIC bathroom accessory, towel ring in stainless steel, wall mounting with concealed fastening and cover rose in stainless steel, Ø 73 mm. Includes fasteners for solid masonry, wood or drywall. Wall construction must be provided with order.

82 8270 01030

FSB METRIC bathroom accessory, toilet roll holder in stainless steel, Ø 22 mm, with roll retainer, wall mounting with concealed fastening and cover rose in stainless steel, Ø 73 mm. Includes fasteners for solid masonry, wood or drywall. Wall construction must be provided with order.

82 8270 01031

FSB METRIC bathroom accessory, reserve toilet roll holder in stainless steel, Ø 22 mm, for one roll, wall mounting with concealed fastening and cover rose in stainless steel, Ø 73 mm. Includes fasteners for solid masonry, wood or drywall. Wall construction must be provided with order. Length 125 mm

82 8201 xxx00

FSB diagonal-oval ErgoSystem, grab handle in stainless steel, ideal grab and support functions, elliptical gripping surface, oval tubing 36.5 × 22 mm, concealed fastening and stainless steel covering profiles, and roses in stainless steel, Ø 73 mm. Includes fasteners for solid masonry, wood or drywall. Wall construction must be provided with order.

82 8201 03000 Length 300 mm

82 8201 04500 Length 450 mm

82 8201 06000 Length 600 mm

82 8201 09000 Length 900 mm

82 8241

FSB convenience stool in pleasant-on-the-skin, hygienic PUR and stainless steel, with rotating seat in PUR, Ø 400 mm, seat height-adjustable from 420 mm to 520 mm, max. loading 150 kg, for propping against the edge of the bath and, in combination with FSB bath seat, can be used as an aid to moving and getting in the bath.

82 8243

FSB free-standing and convenience stool in pleasant-on-the-skin, hygienic PUR and stainless steel, with rotating seat in PUR, Ø 400 mm, seat height 480 mm, with four free-standing feet in stainless steel.