

METRIC
Bathroom Accessories

North American Manual

METRIC®
Bathroom Accessories

North American Manual

About FSB

Designer Series

Lockset Program

Lever, Knob and Trim Designs

Sliding Door Hardware

Door Pulls and Glass Door Hardware

Accessories

Window Handles

Brass and Bronze Products

Door Closers

METRIC Bathroom Accessories

Components

Installation Instructions

Specialty Applications

METRIC®

About FSB	4
METRIC® in Detail	5
New Products	5
Materials and Finishes	6
Overview	7
METRIC® Bathroom Accessories	8
Specification Details	18
Fixing	19

About FSB

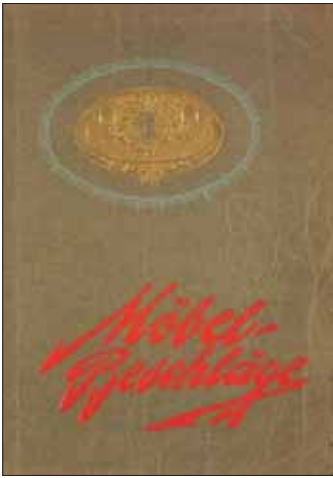

1881

FSB was established in 1881. Together with a modest workforce, company founder Franz Schneider produced antique-style brass cabinet fittings.

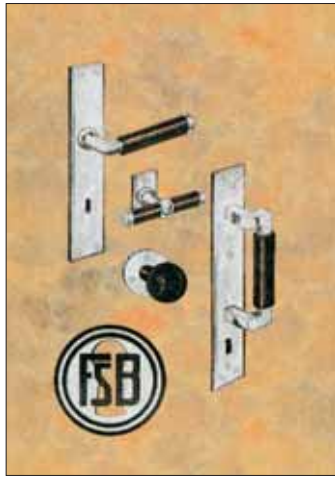

1920s

In the early 1920s, the first door and window fittings appeared in the FSB production program. The design of these years echoed the modernism of the Bauhaus era. Silver metal components were combined with black composite features.



1950s

Beginning with in-house designer Johannes Potente in the 1950s, FSB created the first handles which exemplify minimalism, modernism and ergonomics. FSB is still known for the use of these design principles today.

Four of Potente's lever designs have been included in the permanent collection of the Museum of Modern Art (MoMA).



1990s

Inspired by an international design workshop held in Brakel in 1986, FSB began engaging the market with contemporary designs in an initiative dubbed "Tour d'Europe." Throughout this initiative FSB created design suites with such renowned designers as Philippe Starck, Jasper Morrison, Richard Rogers and many others.

For the past two decades, FSB has continued to work with Architects and Designers to create handles – each with their own personality.



2000s

FSB introduces a limited range of levers supplied in complete locksets to the American design community. The first catalog was approximately 80 pages. Two later catalogs increased FSB's North American offering to nearly 100 lever designs.

In 2007, FSB expanded the North American distribution center, moving it to Madison, CT, where the majority of products are stocked in natural anodized aluminum and satin stainless steel. Stock items can be shipped in 48 hours. All non-stock items can be shipped within two to eight weeks regardless of the product type, finish or project size.

This is FSB's fourth edition for the North American market. It represents a huge step forward to offer a complete program which brings design consistency across more openings and applications.

This catalog is separated into different sections, tailored to your specific needs.

For the latest information please go to www.fsbna.com.

METRIC® in Detail



METRIC Bathroom Accessories

The bathroom is increasingly becoming a place for tranquillity and relaxation. As a result, notions of how such spaces are designed are having to be re-considered too. The concept of “atmosphere” has begun to play an ever more important part alongside purely functional requirements.

Factors such as “naturalness”, “simplicity” and “feeling good” are setting new standards both in the domestic sphere and in hotels and public areas. Growing significance attaches in the process to the selection and combination of natural materials, finishes and colours.

FSB is echoing this trend in the design of its METRIC bathroom accessory series.

The design principle is based on a minimal rectangular post centered on a small round escutcheon. METRIC’s looks are consciously understated, being defined by geometric forms and premium materials. The stylistic contrast between round roses and rectangular-section supports is a thematic thread that runs through the entire series. The combination of the two simultaneously underscores the crisp structuring of the system’s constituent parts.

Its astutely balanced proportions have a soothing effect and blend harmoniously with a variety of design concepts.

Ergonomic criteria have been taken into account wherever they are an aid to fluent sequences of movements. The holder for the toothbrush glass, for instance, tilts towards the user in a manner that facilitates the act of removing the glass.

New Products



Sliding Door Hardware

Building owners are demanding more efficient use of space.

In recognition of this trend FSB has developed an entire range of flush mounted trim for passage, privacy and entry sliding and pocket doors.



Bronze

There is an increase in an “old meets new aesthetic”.

FSB now introduces Bronze as a new material for selected lever handles and accessories.



Glass Door Hardware

Creating more open spaces has become a cornerstone of modern architecture.

FSB has broadened its glass door program to include exposed rolling gears for sliding glass doors.

Material and Finishes

METRIC is supplied in stainless steel. As well as being aesthetically pleasing, stainless steel exudes an authenticity that combines particularly well with natural materials such as wood and granite and makes it a firm contender for inclusion in quality bathroom schemes.

This dependable material has a justifiable reputation for being serviceable, corrosion-resistant, easy to look after and durable.

The quality with which FSB works stainless steel is the upshot of many decades of experience gained from producing well-designed, superlatively engineered hardware for doors and windows.

We have now applied this proficiency in design and manufacture to the METRIC bathroom accessory series.



6204

■ Satin Stainless Steel (630)



6205

■ Mirror Polished Stainless Steel (629)



6206

■ Matte Stainless Steel

METRIC® Bathroom Accessories

● FSB North American Stock Items (stocked in Satin Stainless Steel) ■ Base Material
■ Stainless Steel

8270 0014



Page 8



8270 1013



Page 8



8270 0021



Page 9



8270 xx11



Page 9



8270 0010



Page 9



8270 0015



Page 10



8270 0041



Page 11



8270 0040



Page 11



8270 0017



Page 11



8270 1030



Page 12



8270 xx31



Pages 12 and 13



8270 0042



Page 13



8270 0001



Page 15



8270 0002



Page 15



8270 0003



Page 15



8270 0050



Page 14



8201



Page 16



8241



Page 17



8243



Page 17



METRIC®
Bathroom Accessories



8270 0014

■ Stainless Steel

Combination towel rack
and towel bar

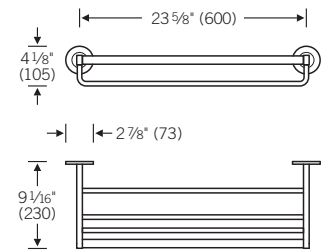

8270 1013

■ Stainless Steel ●

Towel ring

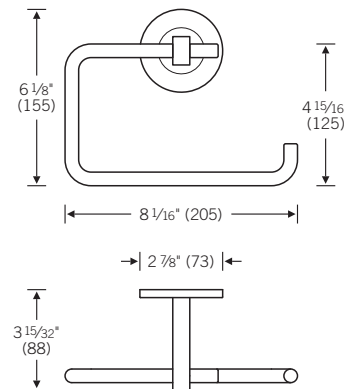

Specification details
cf. Pages 18 and 19

METRIC®
Bathroom Accessories

● FSB North American Stock Items
(stocked in Satin Stainless Steel)

8270 0021

■ Stainless Steel

Double towel bar

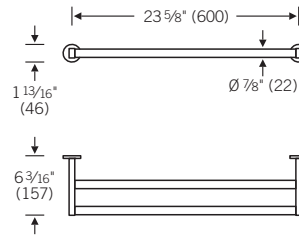

8270 xx11

■ Stainless Steel

Single towel bar

- xx = 45 (450 mm)
- xx = 00 (600 mm)
- xx = 75 (750 mm)
- xx = 90 (900 mm)

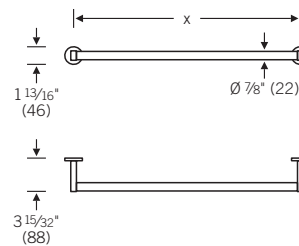

8270 0010

■ Stainless Steel

Swivel action double towel bar

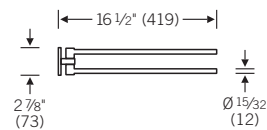
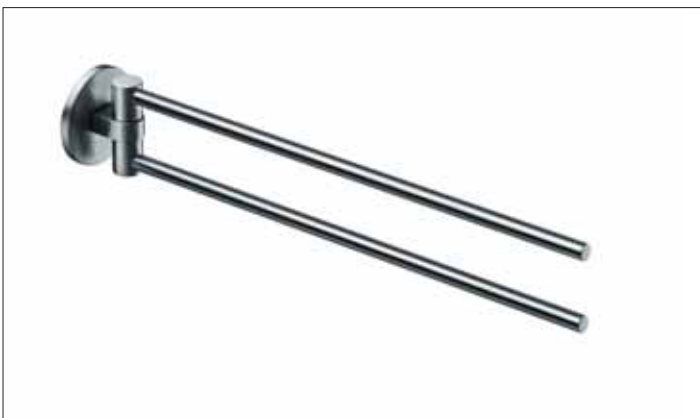

Specification details
cf. Pages 18 and 19

METRIC®
Bathroom Accessories



8270 0015

■ Stainless Steel
Glass

Frosted glass shelf

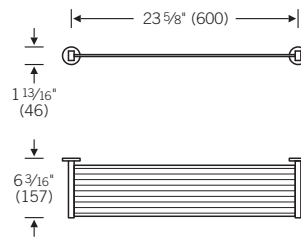

8270 0016

■ Stainless Steel
Glass

Clear glass shelf

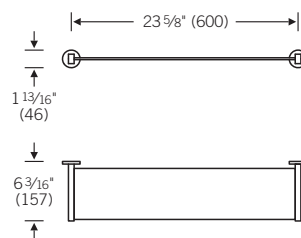

Specification details
cf. Pages 18 and 19

METRIC®
Bathroom Accessories

● FSB North American Stock Items
(stocked in Satin Stainless Steel)

8270 0041

■ Stainless Steel
Glass

Glass holder with glass

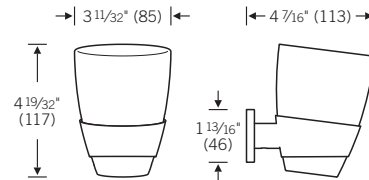

8270 0040

■ Stainless Steel
Plastic

Soap holder with soap dish

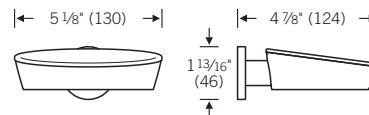

8270 0017

■ Stainless Steel ●

Toothbrush holder

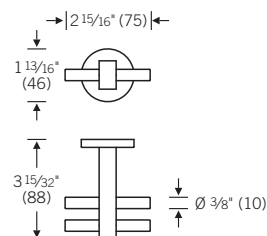

Specification details
cf. Pages 18 and 19

METRIC®
Bathroom Accessories

● FSB North American Stock Items
(stocked in Satin Stainless Steel)



8270 1030

■ Stainless Steel ●

Toilet roll holder

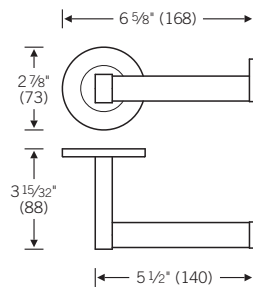

8270 1031

■ Stainless Steel ●

Reserve toilet roll holder
for one roll

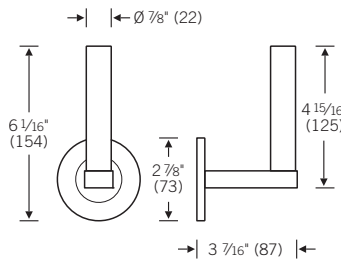

Specification details
cf. Pages 18 and 19

METRIC®
Bathroom Accessories

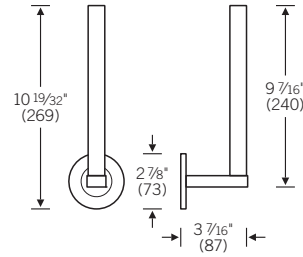

8270 1032

■ Stainless Steel

Reserve toilet roll holder
for two rolls

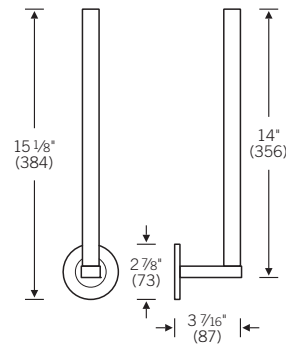

8270 1034

■ Stainless Steel

Paper towel holder



8270 0042

■ Stainless Steel

Toilet brush set

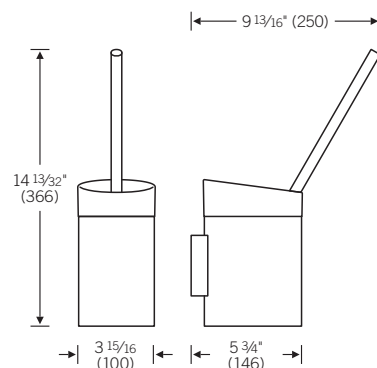

Specification details
cf. Pages 18 and 19

METRIC®
Bathroom Accessories



8270 0050

■ Stainless Steel

Shower bar with sliding
shower-head bracket

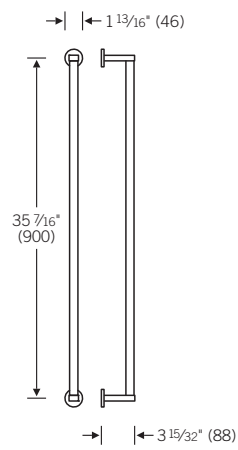

Specification details
cf. Pages 18 and 19

METRIC®
Bathroom Accessories

● FSB North American Stock Items
(stocked in Satin Stainless Steel)

8270 0001

■ Stainless Steel ●

Robe or towel hook

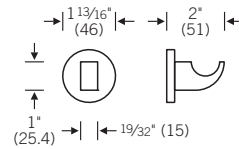

8270 0002

■ Stainless Steel

Robe or towel hook

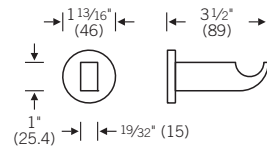

8270 0003

■ Stainless Steel ●

Door stop

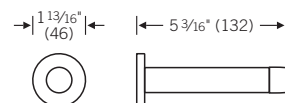

Specification details
cf. Pages 18 and 19

METRIC®
Bathroom Accessories

● FSB North American Stock Items
(stocked in Satin Stainless Steel)

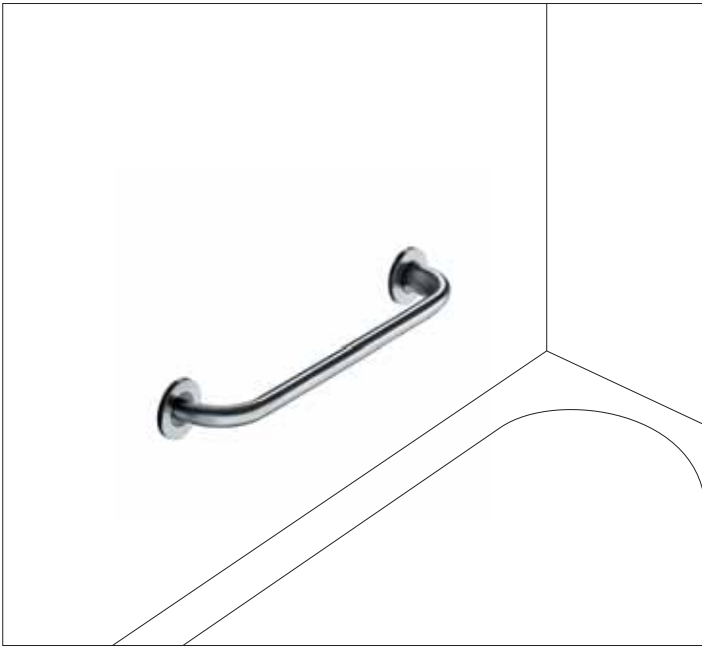

8201 xx60

■ Stainless Steel

Grab bar

- xx = 30 (L = 300 mm)
- xx = 45 (L = 450 mm) ●
- xx = 60 (L = 600 mm) ●
- xx = 90 (L = 900 mm)

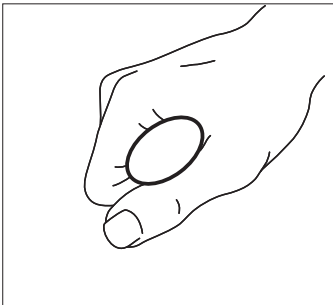
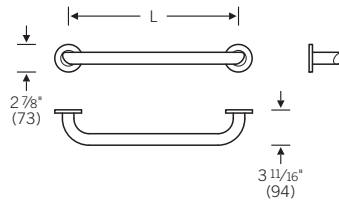

Natural grip

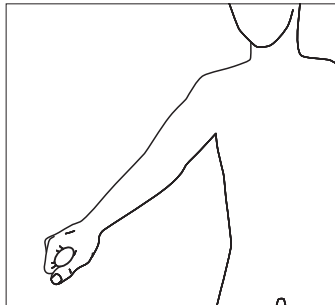

Sturdiness in the diagonal

Numerous companies have done studies confirming the ergonomic advantages of an oval cross section versus a round one.

The advantages of an oval are particularly pronounced when the bar is intended to support the weight of the person gripping it. FSB has demonstrated the advantages of the oval cross section successfully in both door handles and pulls for years.

We are excited to introduce this design element to the bathroom.

Specification details
cf. Pages 18 and 19

METRIC®
Bathroom Accessories

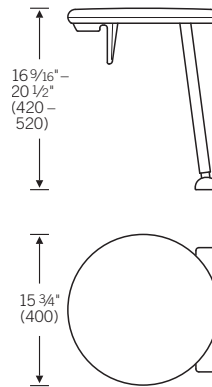

8241

- Stainless Steel (Frame)
- PUR (Seat)

Bath stool with rotating seat

The height-adjustable bath stool with rotating seat is designed with comfort in mind.

Propped up against the edge of the bath, it makes getting into the bath easier. Further bathroom functions such as body care or getting dressed/undressed are likewise facilitated.

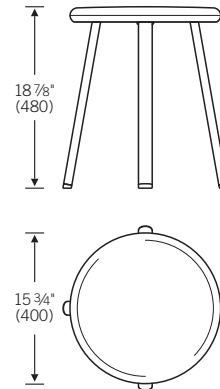

8243

- Stainless Steel (Frame)
- PUR (Seat)

Free-standing bath stool with rotating seat

The free-standing stool has a rotating seat and is very convenient in the bathroom and for getting dressed/undressed.

Specification details
cf. Pages 18 and 19

METRIC®

Specification Details

8270 0001

FSB METRIC bathroom accessory, robe or towel hook in stainless steel, wall mounting with concealed fixing by means of cover rose in stainless steel, Ø 46 mm. Includes fasteners for solid masonry, wood or sheet rock.

Wall construction must be provided with order.
Length 51 mm

8270 0002

FSB METRIC bathroom accessory, robe or towel hook in stainless steel, wall mounting with concealed fixing by means of cover rose in stainless steel, Ø 46 mm. Includes fasteners for solid masonry, wood or sheet rock.

Wall construction must be provided with order.
Length 89 mm

8270 0003

FSB METRIC bathroom accessory, door stop in stainless steel, wall mounting with concealed fixing by means of cover rose in stainless steel, Ø 46 mm. Includes fasteners for solid masonry, wood or sheet rock.

Wall construction must be provided with order.
Length 132 mm

8270 0010

FSB METRIC bathroom accessory, swivel action double towel bar in stainless steel, Ø 12 mm, wall mounting with concealed fixing by means of cover rose in stainless steel, Ø 73 mm. Includes fasteners for solid masonry, wood or sheet rock.

Wall construction must be provided with order.
Length 419 mm

8270 xx11

FSB METRIC bathroom accessory, towel bar in stainless steel, Ø 22 mm, side-bearers in stainless steel, wall mountings with concealed fixing by means of cover roses in stainless steel, Ø 46 mm. Includes fasteners for solid masonry, wood or sheet rock.

Wall construction must be provided with order.

8270 4511 Length 450 mm
8270 0011 Length 600 mm
8270 7511 Length 750 mm
8270 9011 Length 900 mm

8270 0014

FSB METRIC bathroom accessory, combination towel rack and towel bar in stainless steel, wall mounting with concealed fixing by means of cover rose in stainless steel, Ø 73 mm, 230 mm deep rack with Ø 22 mm towel bar. Includes fasteners for solid masonry, wood or sheet rock.

Wall construction must be provided with order.

8270 0015

FSB METRIC bathroom accessory, glass wall-mounted shelf, in unbreakable glass (toughened safety glass), side-bearers in stainless steel, plastic wall mountings with concealed fixing by means of cover roses in stainless steel, Ø 46 mm. Includes fasteners for solid masonry, wood or sheet rock.

Wall construction must be provided with order.

Surface area of tray
600 × 135 mm
Frosted finish

8270 0016

FSB METRIC bathroom accessory, glass wall-mounted shelf, in unbreakable glass (toughened safety glass), side-bearers in stainless steel, plastic wall mountings with concealed fixing by means of cover roses in stainless steel, Ø 46 mm. Includes fasteners for solid masonry, wood or sheet rock.

Wall construction must be provided with order.

Surface area of tray
600 × 135 mm
Plain glass finish

8270 0017

FSB METRIC bathroom accessory, toothbrush holder in stainless steel, wall mounting with concealed fixing by means of cover rose, Ø 46 mm, in stainless steel. Includes fasteners for solid masonry, wood or sheet rock.

Wall construction must be provided with order.

8270 0021

FSB METRIC bathroom accessory, double towel bar in stainless steel, Ø 22 mm, side-bearers in stainless steel, wall mountings with concealed fixing by means of cover roses in stainless steel, Ø 46 mm. Includes fasteners for solid masonry, wood or sheet rock.

Wall construction must be provided with order.

Length 600 mm

8270 0040

FSB METRIC bathroom accessory, soap holder in stainless steel, for washstand, with removable plastic soap tray (polycarbonate), wall mounting with concealed fixing by means of cover rose in stainless steel, Ø 46 mm. Includes fasteners for solid masonry, wood or sheet rock.

Wall construction must be provided with order.

8270 0041

FSB METRIC bathroom accessory, glass holder in stainless steel, for washstand, with ergonomic styling, tilting of holder conducive to ease of removal, wall mounting with concealed fixing by means of cover rose in stainless steel, Ø 46 mm. Includes fasteners for solid masonry, wood or sheet rock.

Wall construction must be provided with order.

8270 0042

FSB METRIC bathroom accessory, toilet brush set in stainless steel and plastic (polycarbonate), for wall fixing, nylon brush head. Replaceable brush is automatically centred and positioned, for removal in line with body movements, large insertion aperture, easy to clean due to removable brush receptacle, with inner reservoir for disinfectants, concealed fixing. Includes fasteners for solid masonry, wood or sheet rock.

Wall construction must be provided with order.

METRIC®

Specification Details

8270 0050

FSB METRIC bathroom accessory, shower rail in stainless steel, Ø 22 mm, with continuously adjustable shower head holder, supports in stainless steel, wall mountings with concealed fixing by means of cover rose in stainless steel, Ø 46 mm. Includes fasteners for solid masonry, wood or sheet rock. Wall construction must be provided with order. Length 900 mm

8270 1013

FSB METRIC bathroom accessory, towel ring in stainless steel, wall mounting with concealed fixing by means of cover rose in stainless steel, Ø 73 mm. Includes fixing for solid masonry, wood or sheet rock. Wall construction must be provided with order.

8270 1030

FSB METRIC bathroom accessory, toilet roll holder in stainless steel, Ø 22 mm, with roll retainer, wall mounting with concealed fixing by means of cover rose in stainless steel, Ø 73 mm. Includes fasteners for solid masonry, wood or sheet rock. Wall construction must be provided with order.

8270 1031

FSB METRIC bathroom accessory, reserve toilet roll holder in stainless steel, Ø 22 mm, for one roll, wall mounting with concealed fixing by means of cover rose in stainless steel, Ø 73 mm. Includes fasteners for solid masonry, wood or sheet rock. Wall construction must be provided with order. Length 125 mm

8270 1032

FSB METRIC bathroom accessory, reserve toilet roll holder in stainless steel, Ø 22 mm, for two rolls, wall mounting with concealed fixing by means of cover rose in stainless steel, Ø 73 mm. Includes fasteners for solid masonry, wood or sheet rock. Wall construction must be provided with order. Length 240 mm

8270 1034

FSB METRIC bathroom accessory, reserve toilet roll holder in stainless steel, Ø 22 mm, for three rolls, wall mounting with concealed fixing by means of cover rose in stainless steel, Ø 73 mm. Includes fasteners for solid masonry, wood or sheet rock. Wall construction must be provided with order. Length 356 mm

8201 xx60

FSB diagonal-oval ErgoSystem, grab handle in stainless steel, ideal grab and support functions, elliptical gripping surface on account of oval tubing 36.5 × 22 mm, concealed fixing by means of stainless steel covering profiles, fixing roses in stainless steel, Ø 73 mm. Includes fasteners for solid masonry, wood or sheet rock. Wall construction must be provided with order.
 8201 3060 Length 300 mm
 8201 4560 Length 450 mm
 8201 6060 Length 600 mm
 8201 9060 Length 900 mm

8241

FSB convenience stool in pleasant-on-the-skin, hygienic PUR and stainless steel, with rotating seat in PUR, Ø 400 mm, seat height-adjustable from 420 mm to 520 mm, max. loading 150 kg, for propping against the edge of the bath and, in combination with FSB bath seat, can be used as an aid to moving and getting in the bath.

8243

FSB free-standing and convenience stool in pleasant-on-the-skin, hygienic PUR and stainless steel, with rotating seat in PUR, Ø 400 mm, seat height 480 mm, with four free-standing feet in stainless steel.

Fixing

The base rose (wall mounting) contains two parallel slots for optimum positioning and is screwed to the wall using the fixing material supplied. The cover rose is then pressed home and the pattern aligned as required.

Final visual adjustment of the functional components is performed by firmly tightening the hexagon socket screw against the tensioning bolt.

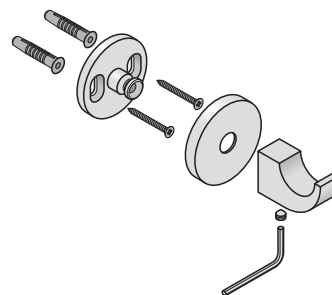



FSB

North America

1 Bishop Lane
Madison, CT 06443

Tel 203 404 4700
Fax 203 404 4710

www.fsbna.com
info@fsbna.com

© FSB. All Rights Reserved.

100111 · 2008